

SERIES 90K FEATURES

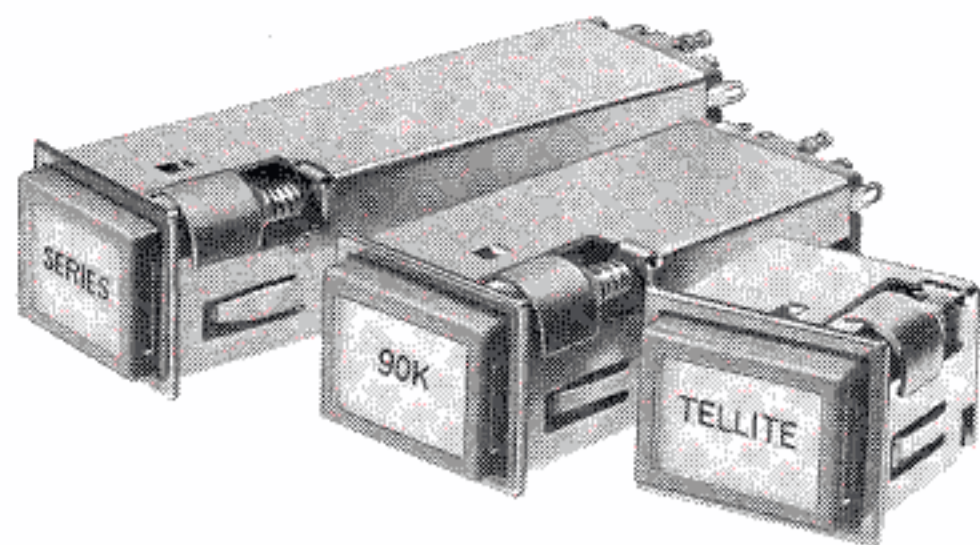

The series 90K Telite units are available in two versions as an indicator-lite only or as a switch-lite. Package sizes of each version are shown in the dimensional drawings below. Units are available with a choice of wiring terminals. All units may be specified with solder lugs or plug-in connector pins. In addition, indicator-lite only units may be specified with screw-type terminals. Each unit incorporates mounting tabs that provide a positive hard mount after inserting the unit through the panel cutout from the panel-front. Captive mounting screws inside the unit cam these mounting tabs and tighten them up against the back of the panel. No external hardware required.

INDICATOR UNIT

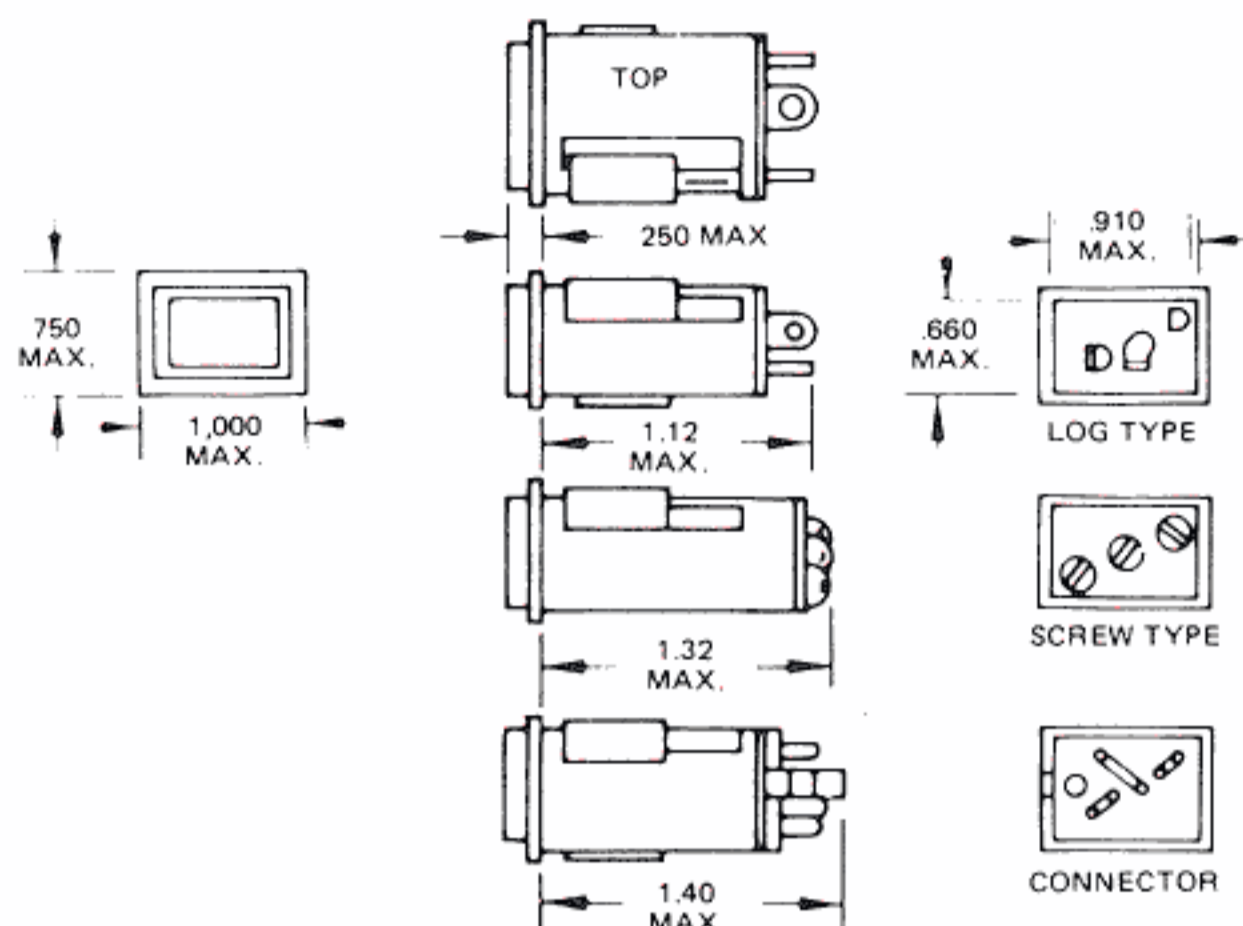

Outline dimensions to be used for Indicator-Lite and Press To Test.

SWITCH-LITE UNIT

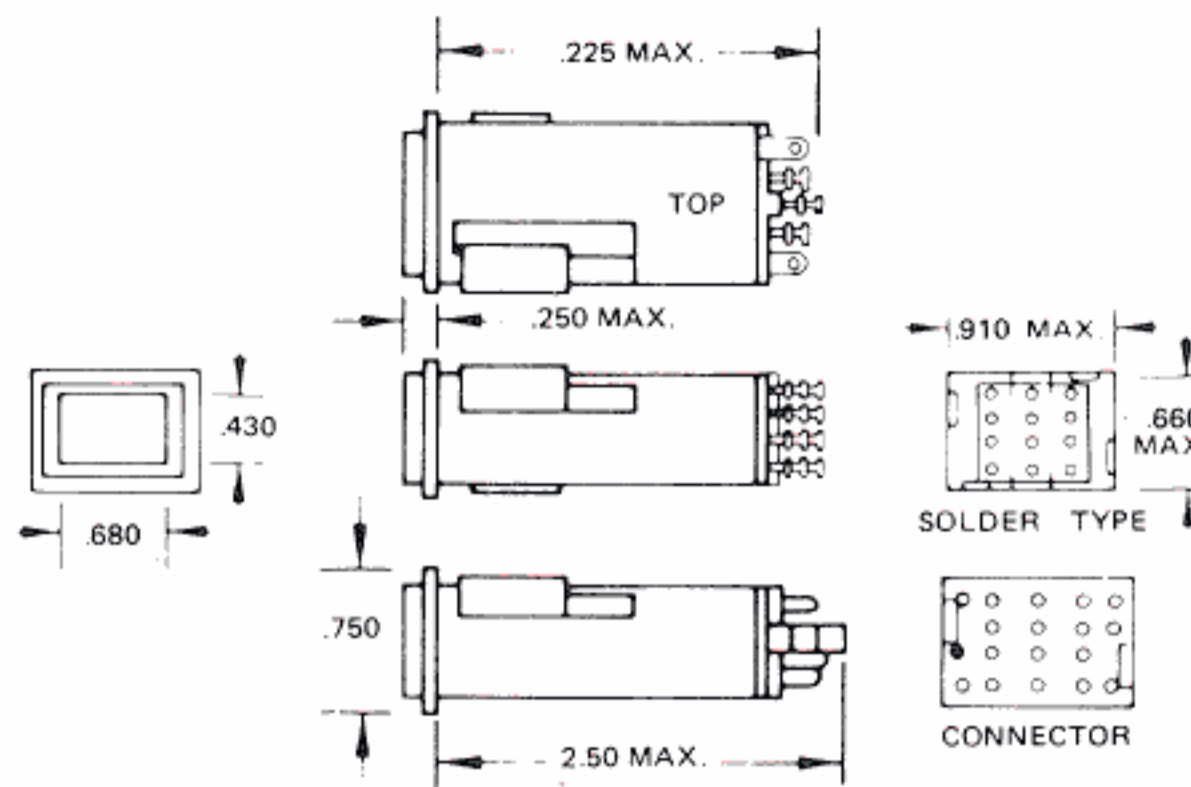

Outline dimensions to be used for Switch-Lite with Momentary or Alternate action; or for Indicator-Lite with control circuits.

NOTE: The two drawings above include the lens retainer and space required for solder lug, connector pin, and screw type (where applicable) terminals. Dimensions for the connector block are shown separately on page 7.

PANEL CUTOUT

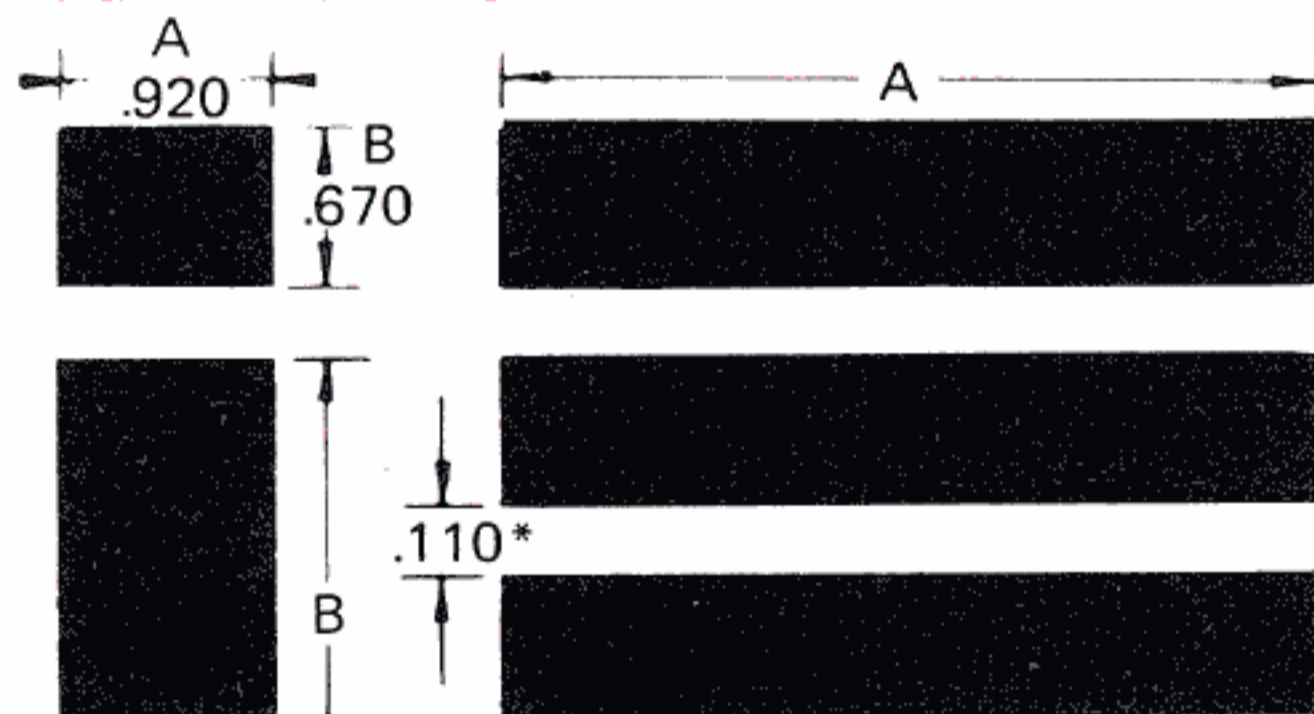

The panel cutout shown may be used for both housings shown above.

1. The unit will mount in panels 1/16" to 3/16" thick. For units to fit other panel thicknesses, contact the factory.
2. When mounting unit on end, side marked "top" is on the left as viewed from the front of the panel.

PANEL CUT-OUT DIMENSIONS IN INCHES (+.010)

NO. OF UNITS IN ROW	1	2	3	4	5	6	7	8
Horizontal Row "A"	.920	1.925	2.930	3.935	4.940	5.945	6.950	7.955
Vertical Row "B"	.670	1.425	2.180	2.935	3.690	4.445	5.200	5.955

For matrix arrangement, allow .110" in panel between cut-outs for adjacent horizontal or vertical rows.

LAMP AND SWITCH TERMINAL IDENTIFICATION

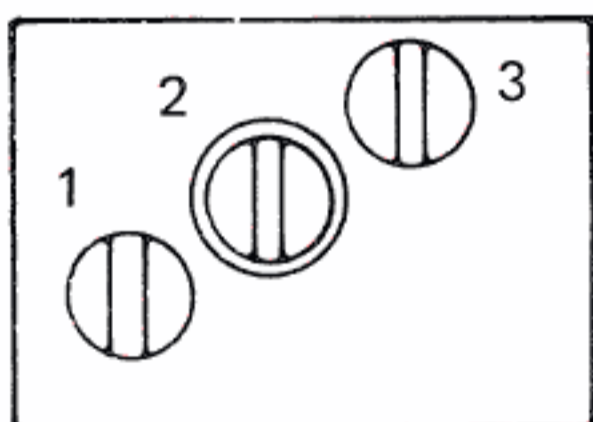

Indicator Only with Screw Terminals

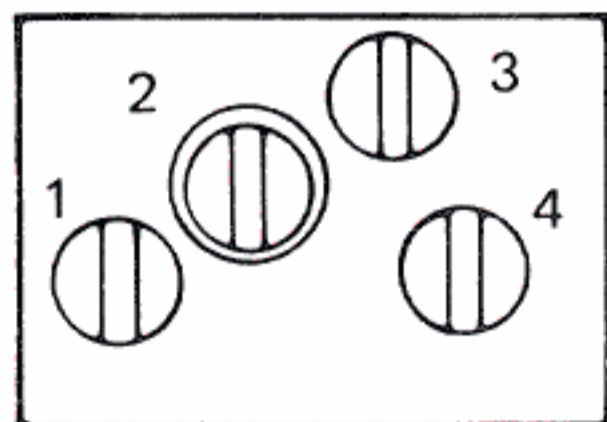

Press to Test with Screw Terminals

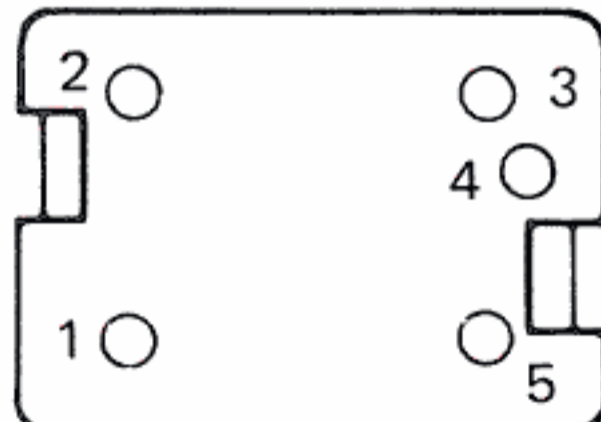

Connector type Indicator with control circuitry (see page 4)

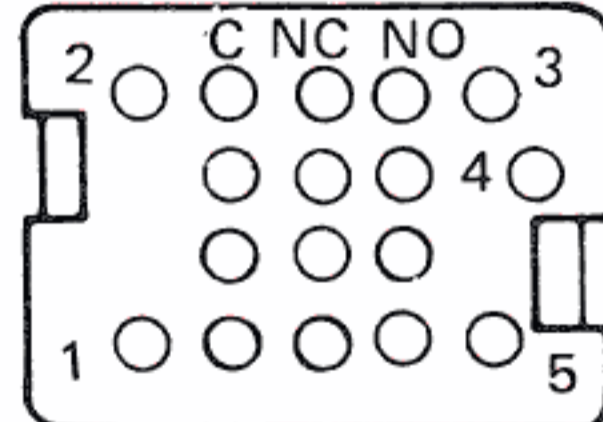

Switch Connector Type

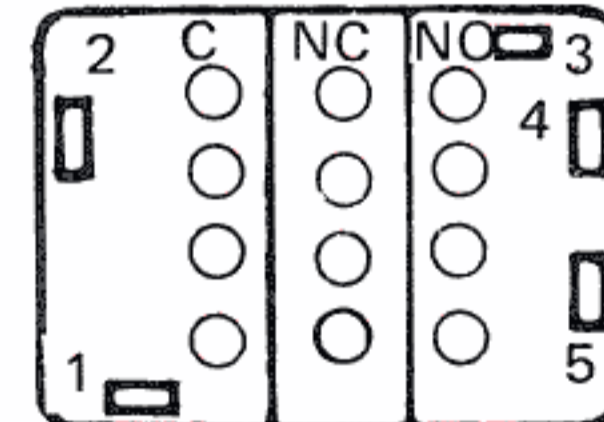

Switch with Solder Post



Lamp Schematic

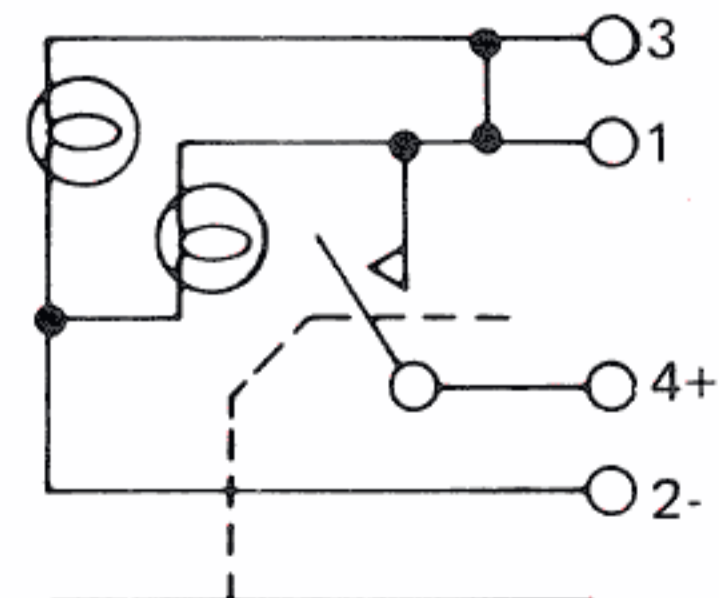

Press To Test (Press front lens to test)

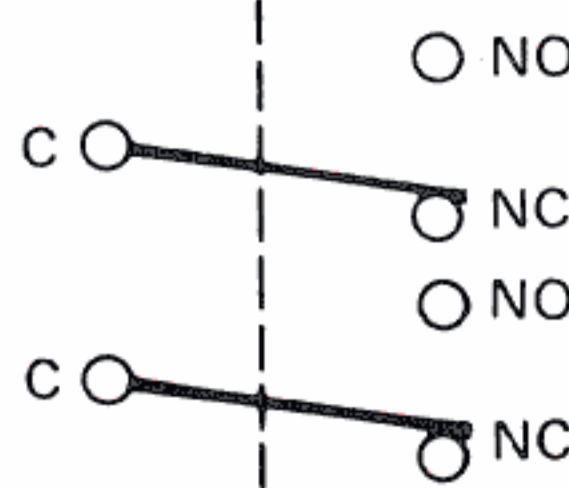

Switch Schematic (2 SPDT shown)

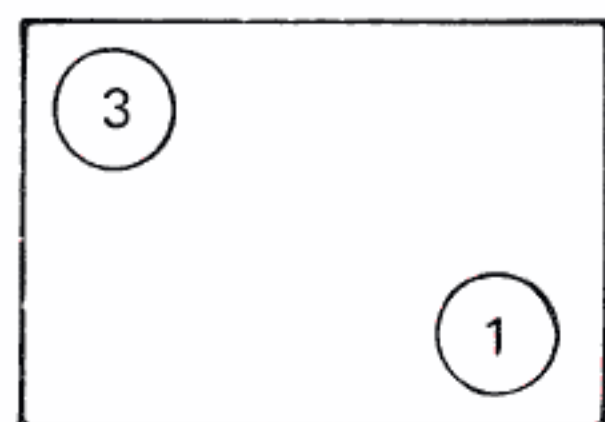

Front View Showing Lamp Location

NOTES:

1. On 2 PDT switches, switch terminals are furnished in center only.
2. Double-Turret Terminals will accept two No. 20 AWG wire leads. (See specifications, Page 3.)



90K	<input type="checkbox"/>	A1C2	D1	E5	F1	G1	H1	J1 ()	L1		R12	ON OFF
Series Number	Basic Unit Variation	Basic Unit	Terminals	Control Circuits (Indicator units only)	Lamps	Lens Type	RF1 Screen	Color Filters	Display Screen	Front Lens	Legend Configuration	Legend Wording

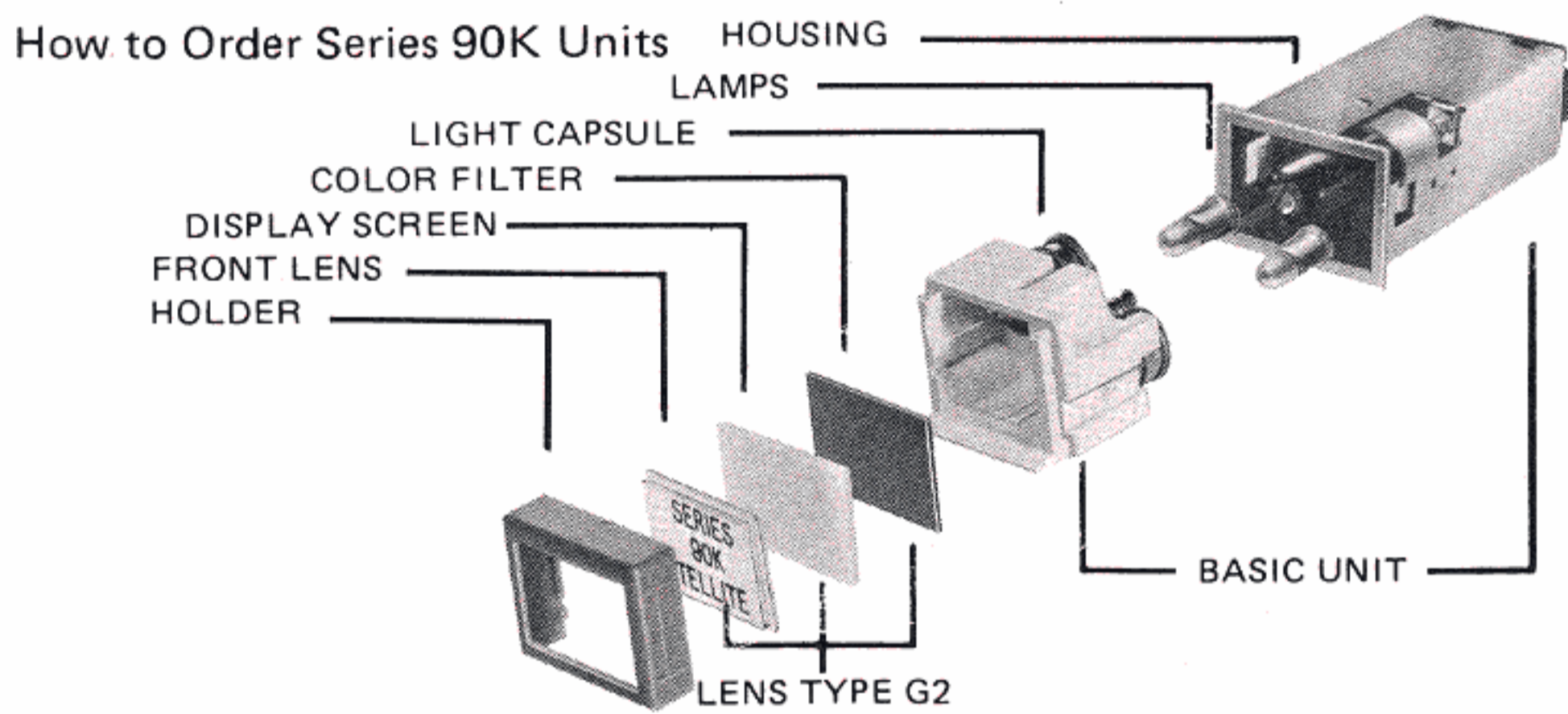

Component parts of a complete indicator unit (type G2 lens assembly shown).

Complete Switch-Lite and Indicator-Lite assemblies may be ordered using a single coded part number. Each item required for a complete assembly has been assigned a code number and is described on the following pages. By selecting the part number code for each item desired, and then placing these numbers in alphabetical sequence immediately following the series number "90K", a complete part number is formulated. Above is the code number sequence to be used in ordering.

ELIMINATION OF ITEMS

Where one or more items comprising a complete unit are not required, omit the code number for that item.

ORDERING SEPARATE ITEMS

When separate items are required, precede an item's code number with the basic "90K" to obtain the correct order number for that item. Lamps, when ordered separately, are always considered 1 each rather than 2.

BASIC UNIT VARIATIONS

Variations of the basic unit, such as units with connector pins, may be specified in this space. Future expansions of the line, which will be described in Supplement Sheets to this Catalog, may also be specified here if applicable.

BASIC UNIT CODE NUMBERS	
Basic Unit Type	Indicator or Switch-Lite Code
Indicator only (U.L. approved)	A1
2PDT momentary switch	A1C2
4PDT momentary switch	A1C3
2PDT alternate switch	A1C4
4PDT alternate switch	A1C5
Press to Test (Indicator Only) (screw type terminals only)	A6D2

SERIES 90K SPECIFICATIONS

GENERAL

- Basic unit types available**
Indicator Lite, Switch Lite. Press to test indicator.
- Switch configurations and actions**
2PDT or 4PDT, momentary or alternate action.
- Lamp types/number of lamps/voltage**
Two T 1 1/2 incandescent, 6, 12, or 28 volt based lamps (115 VAC neon lamps available).
- Lamp circuits available**
Common ground
- Display screen arrangements**
Full display, two-way vertical or horizontal split, two-color full display.
- Color control method**
Slab filter in yellow, amber, red, green, blue, and white. Projected color (silicone rubber bulb boots) also available.
- Lens types available**
Lighted letters or lighted background, letters either legible or not when unit is unlighted.
- Engraving size**

110' high with .017" stroke (standard).

- Relamping**
Front of panel without tools.
- Mounting method**
Hard mount from front of panel with integral mounting nuts.
- Mounting panel thickness**
1/16" to 3/16".
- Wiring terminations**
Switch: double turret, connector pins.
Indicator: solder lugs, connector pins, screw type.
- Wire sizes**
Screw type and solder lug terminals accept up to 2 #20 gauge wires.
Connector pin type terminals accept #20 through 28 gauge wires.
- Optional features available**
Control Circuits, Drip Proof Seal, RFI Screen, Spacer Barriers, Switch Guard, Panel Plug, Crimp Tool, Locator Removal Tool.

ELECTRICAL AND MECHANICAL CHARACTERISTICS

- Operation**
Momentary or Alternate
- Action**
Snap-action

- Contacts**
2 PDT or 4PDT
- Contact ratings**
3 amps resistive @ 115 to 220 VAC;
3 amps resistive, 1.5 amps inductive @ 28 VDC (minimum - 10mA@5V)
- Contact resistance (initial)**
50 Milliohms @ 6 VDC and 10 ma
- Operation force**
64 oz. max.
- Feel**
Tactile
- Mechanical life**
100,000 cycles (on and off = 1 cycle)
- Electrical life** - 25,000 cycles
- Stroke** - .125" nominal
- Tease Proof** - Yes, 100%

ENVIRONMENTAL

- Operating temperature range**
-55°C to +85°C
- Terminal strength**
5 lbs. parallel and perpendicular per MIL-STD-202, Method 211, Cond. A
- Actuator and stop strength**
25 lbs. for 1 minute
- Thermal shock**
-55°C to +85°C, per MIL-STD-202,

- Method 107, Cond. A
- Dielectric strength**
1000 volts, per MIL-STD-202, Method 301
- Insulation resistance (initial)**
500 VDC for 1 minute, 1000 megohms minimum per MIL-STD-202, Method 302, Cond. B
- Shock**
MIL-STD-202, Method 202
- Vibration**
10 G's at 10 to 500 Hz, per MIL-STD-202, Method 204B, Cond. A
- Salt Spray**
48 hours per MIL-STD-202, Method 101C, Cond. B
- Moisture resistance**
Per MIL-STD-202D, Method 106C, 240 hrs, 98%RH
- Sand and dust**
6 hours, per MIL-STD-202, Method 110, Cond. B
- Overload**
50 cycles at 6 amps, 28 VDC
- RFI, EMI**
70 DB minimum relative attenuation in the frequency range of 10K Hz to 10,000 M Hz, per MIL-STD-285.

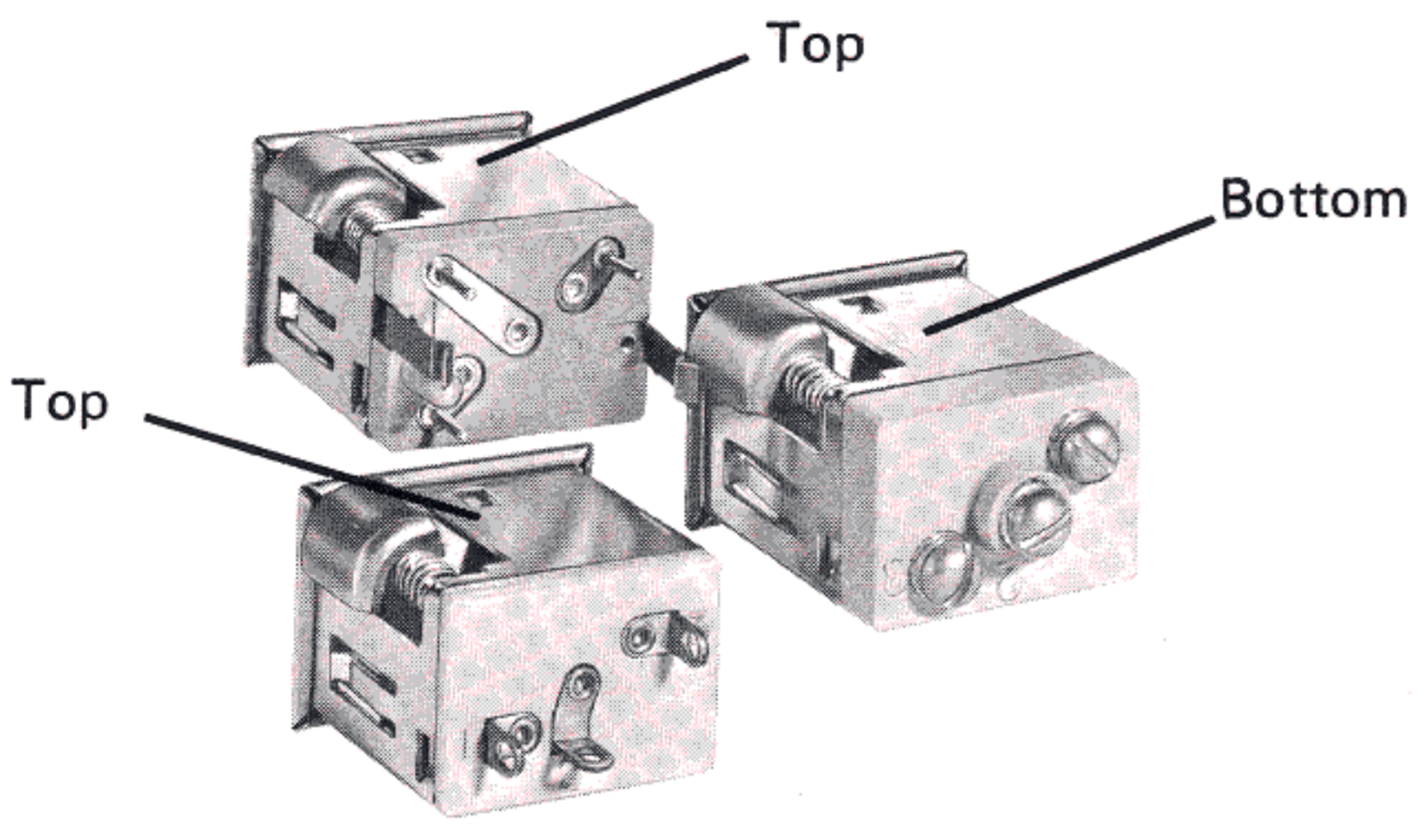

TERMINALS

Series 90K units are available with a choice of wiring terminals. All units may be specified with solder lugs or plug-in connector pins (except Press to Test). In addition, Indicator-Lites may be specified with screw-type terminals. To specify the proper terminals, insert the appropriate code number in the basic ordering sequence.

CODE	TERMINAL
D1	Solder lug
D2	Screw-type (Indicator Only)
D3	Connector pin

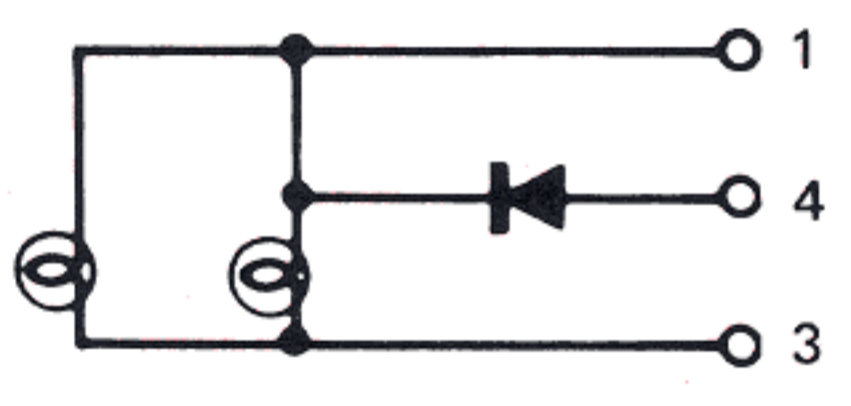

Control Circuit E5
Test D.C. Positive Input
(For D.C. Negative Input specify E12)

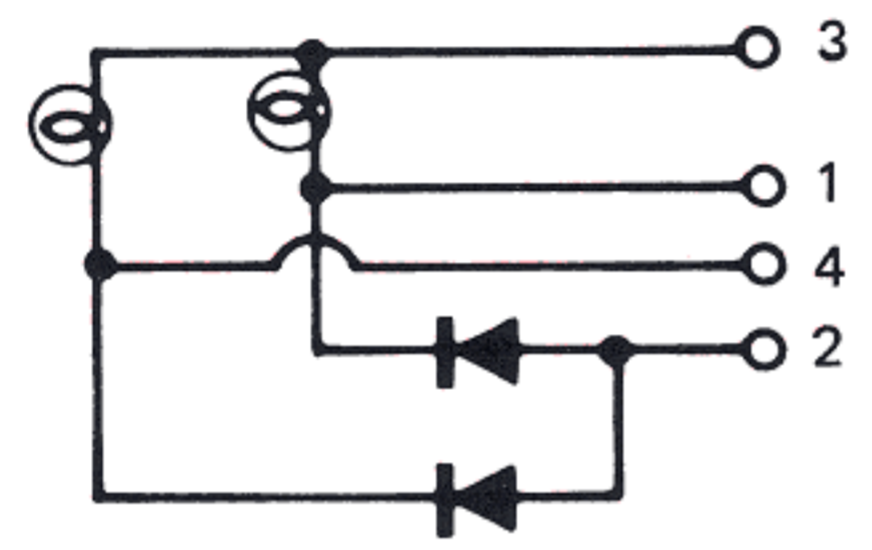

Control Circuit E7
Test Divided Light
D.C. Positive Input (For D.C. Negative Input specify E 14)

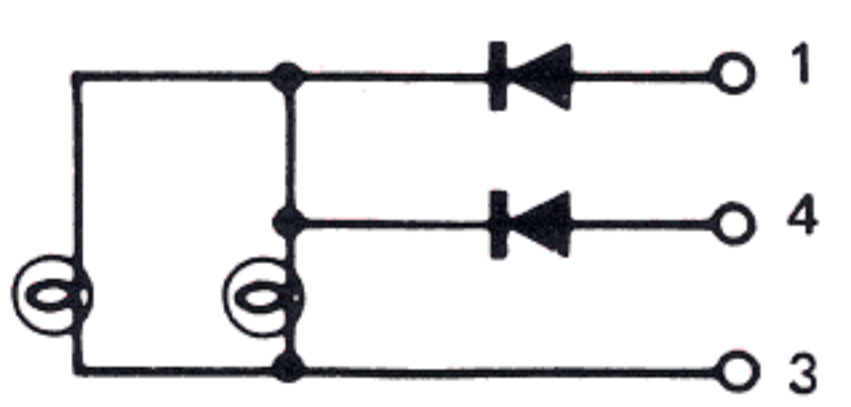

Control Circuit E6
Test With Blocking Diode
D.C. Positive Input (For D.C. Negative Input specify E13)

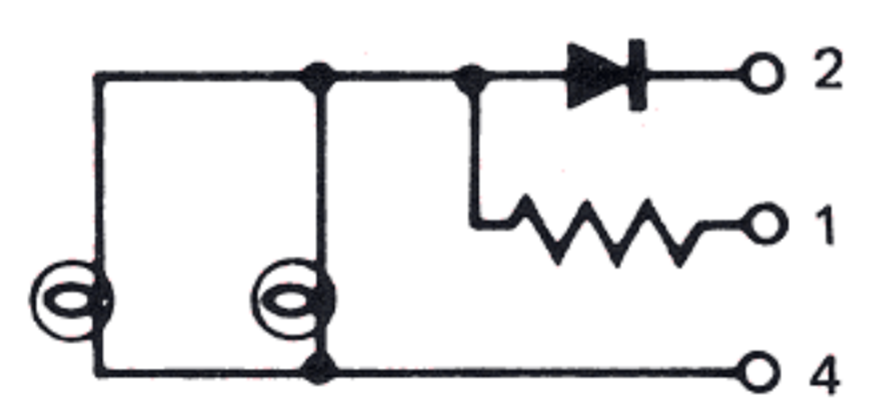

Control Circuit E9
Test & Diode Dimming
D.C. Positive Input (For D.C. Negative Input specify E16)

CONTROL CIRCUITS (Indicators Only)

Special circuits which provide master lamp test and dimming capabilities are available as an integral part of the basic unit. These circuits eliminate the need for external circuitry and are available in four standard circuits which provide positive and negative test inputs for all full display screen styles. Other control circuits are available on request.

NOTE: The indicator only units with control circuits are the same package size as switch-lite units.

LAMPS

Series 90K units accept two T 1 3/4 midget flanged base lamps. To specify, insert the appropriate code number in the basic ordering sequence.

CODE	LAMP
F1	6 volt incandescent
F2	12 volt incandescent
F3	28 volt incandescent
F14	28 volt long life incandescent
F4	115 volt neon with resistor (*)
F10	115 volt neon without resistor (for use with external resistor)*

*Recommended for use with red or amber color filters only.

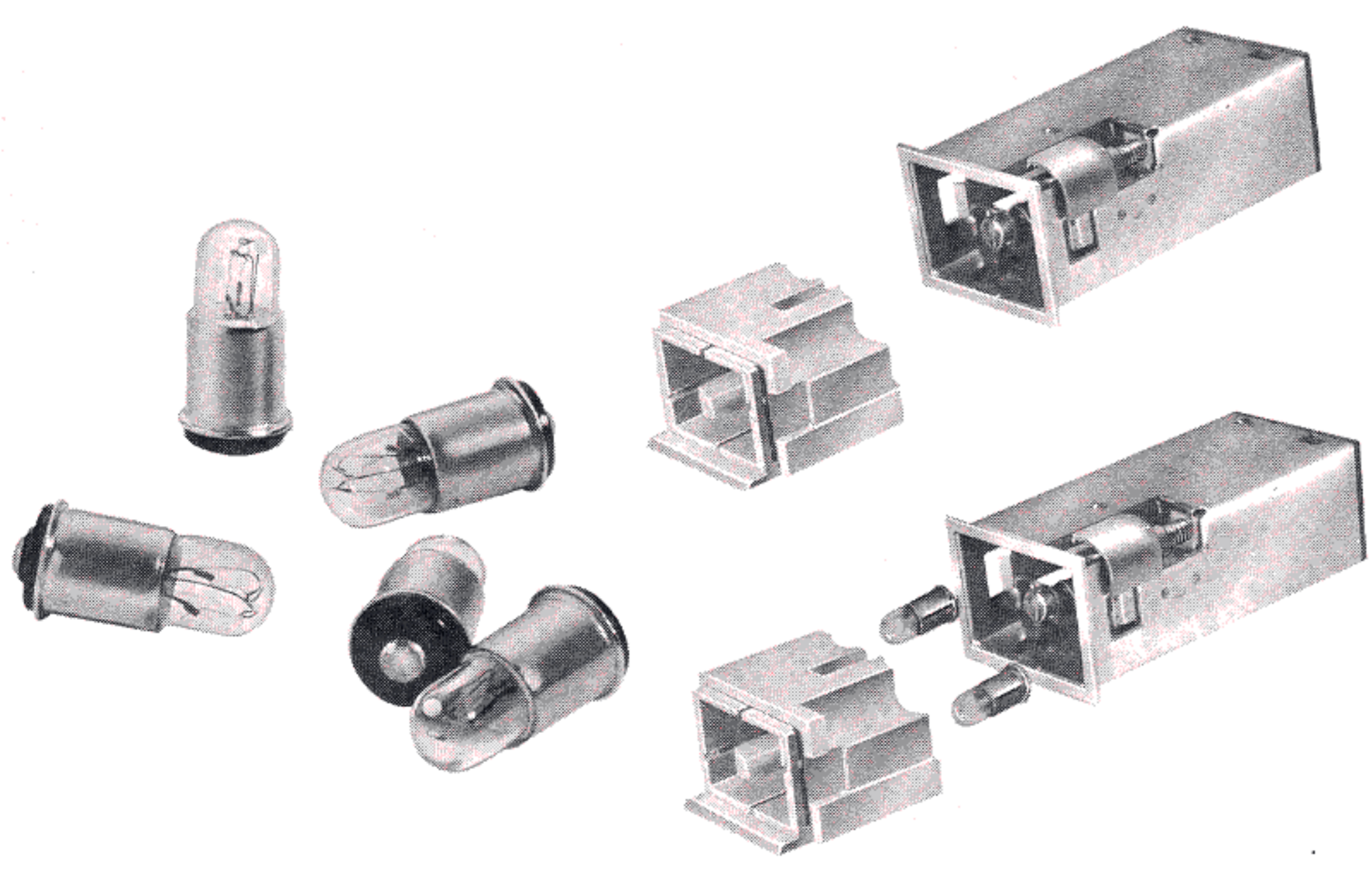

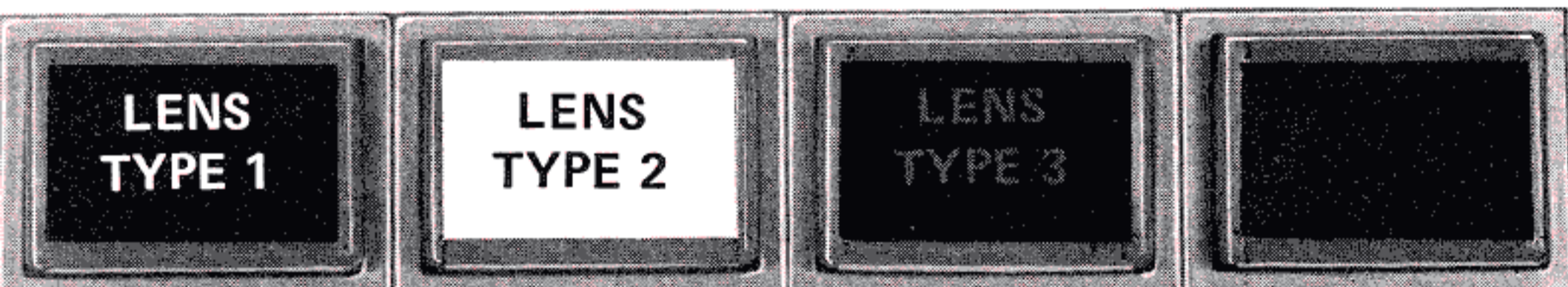

LENS TYPE

Series 90K units are available with four types of lenses, each producing a different type of legend display. To order, use the appropriate "G" code number from those described below.

EASY LENS REPLACEMENT

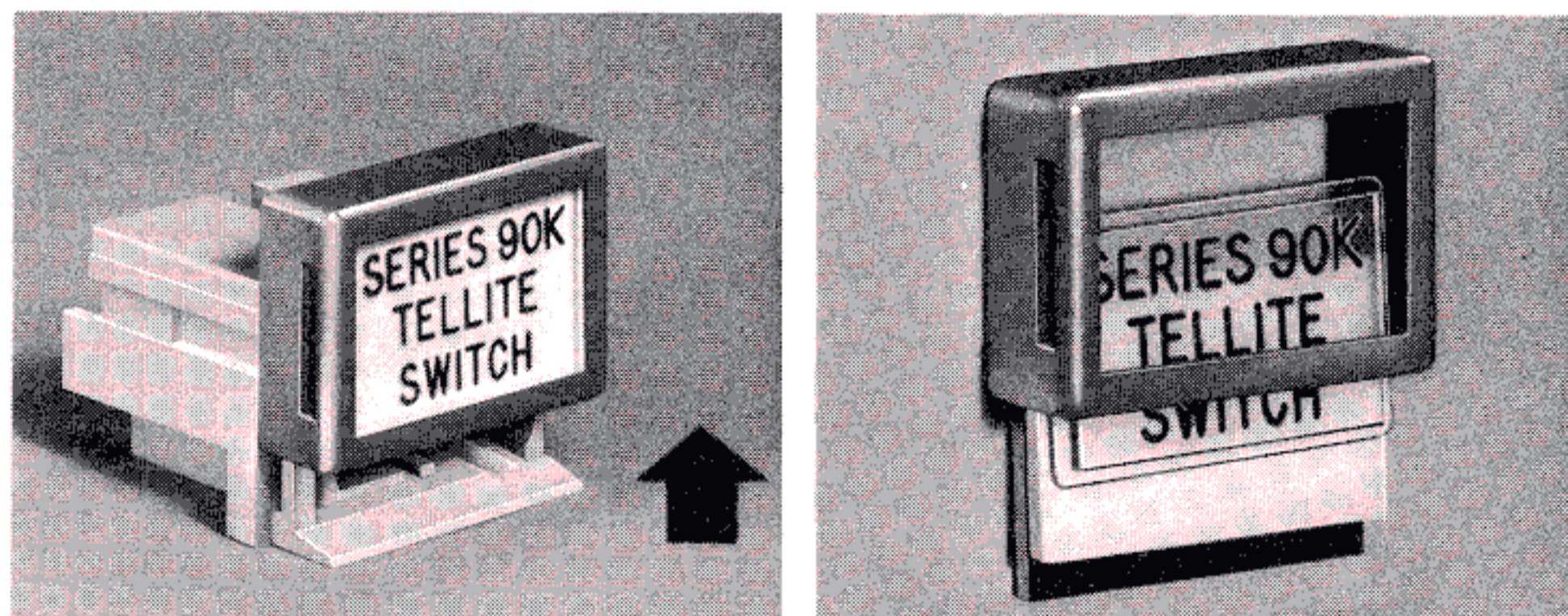

LENS TYPE CODE	DESCRIPTION
G1	Lighted Letters: Letters appear white on a black background until illuminated, then letters appear in color, background remains black.
G2*	Lighted Background: Letters appear black on a white background until illuminated and then background appears in color, letters remain black.
G3	Lighted Letters: Letters are not legible until illuminated and then letters appear in color, background is black.
G4	Lighted Background: Letters are not legible until illuminated, then background appears in color, letters are black.

*This is the most commonly used and preferred type of lens for most applications.

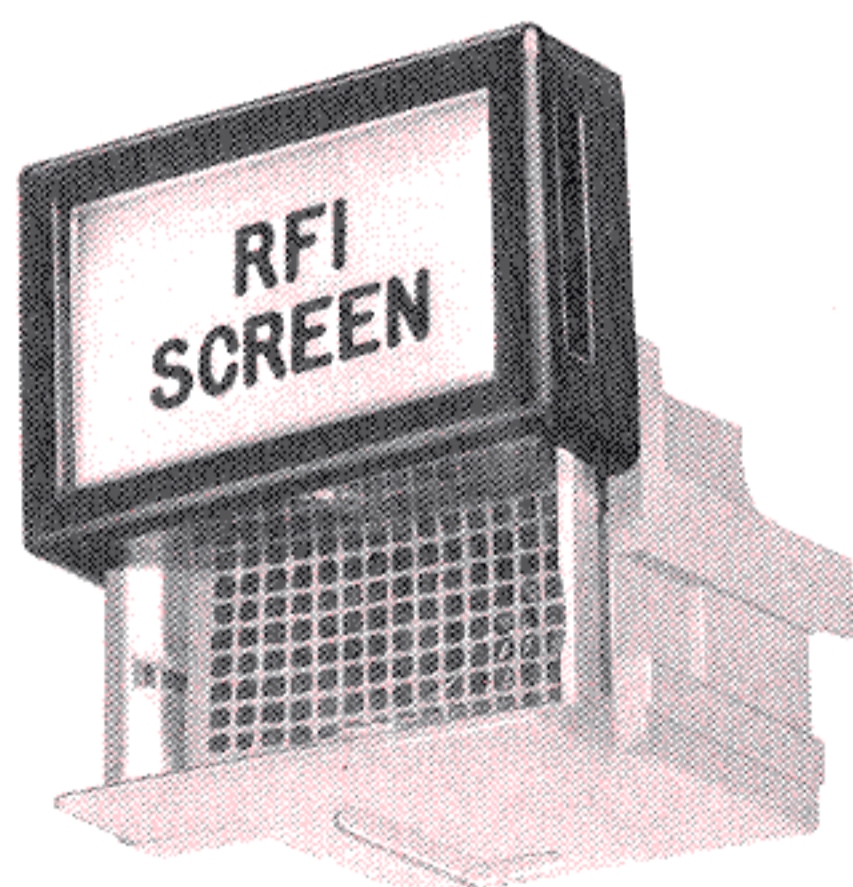

RFI SCREENS

The passage of radiated and/or conducted RFI through panel cutouts can be reduced by the fine mesh, metal RFI screen which is mounted between the lamps and display screen of the light capsule. RFI is grounded by electrical contact from the screen to the unit housing to the panel. Available for full, horizontal and vertical split displays.

To order RFI screens for complete units, insert the code number shown below, according to the screen configuration, into the basic ordering sequence.

CODE NUMBER	DESCRIPTION
H1	Full Display RFI Screen
H2	Horizontal Split Display RFI Screen
H3	Vertical Split Display RFI Screen

To order RFI screens as separate parts, consult factory for ordering information.

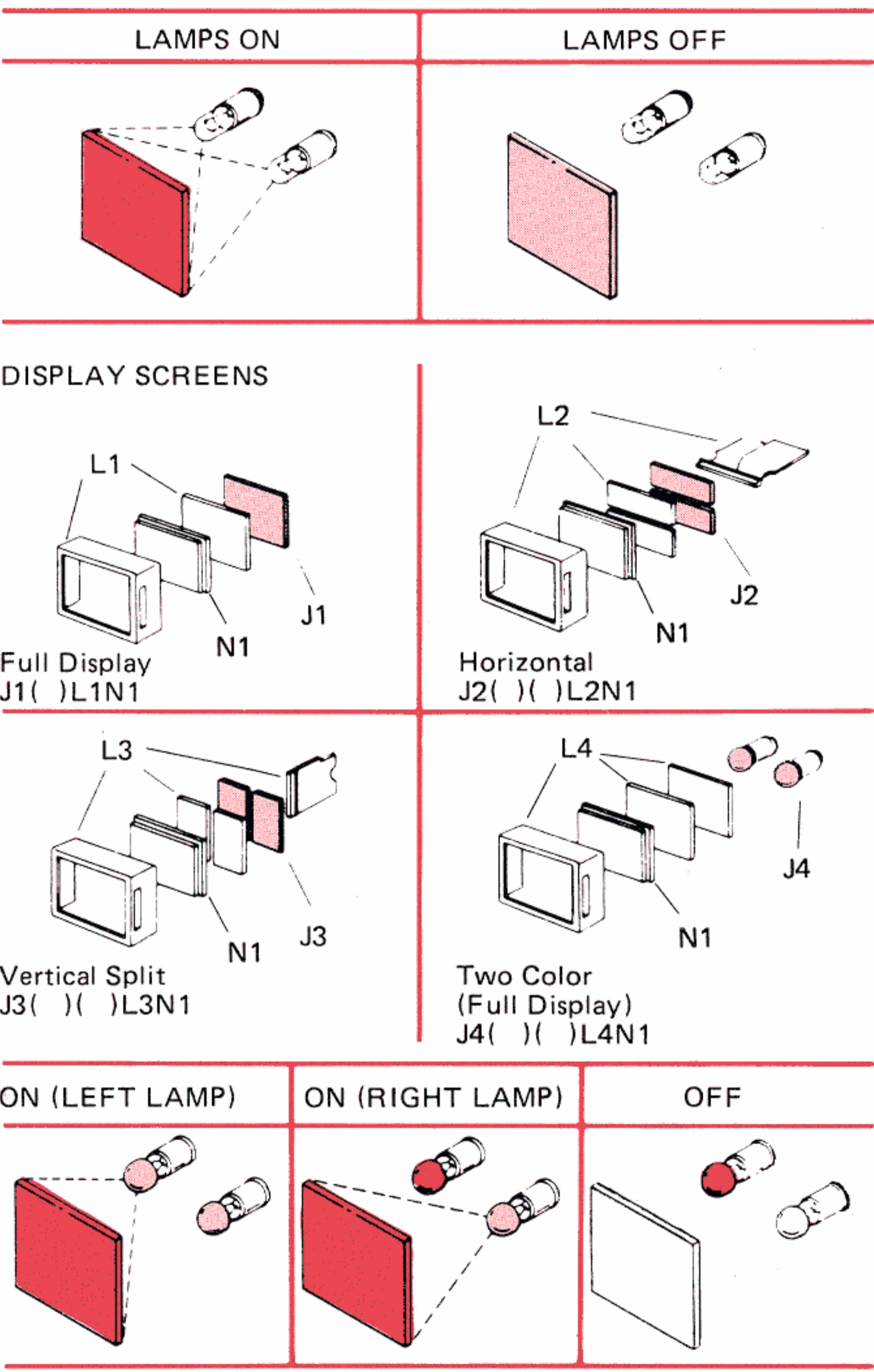

TRANSMITTED COLOR (Slab filters)

To order a color slab filter for a Series 90K unit for a specific display arrangement, use the code numbers shown at the left for the desired display, followed by the color code letter desired in parenthesis. In a horizontal split, the first color code denotes the top half of the display, the second color denotes the bottom half. In a vertical split, the first color code denotes the color for the left half of the display, the second color code denotes the color for the right half, as viewed from the front.

The code number includes the holder and dividers, and spacers where applicable. Full displays or horizontally or vertically split displays, and two color full displays, are available. The coded part number, "L1", etc., also includes the holder for the lens assembly.

PROJECTED COLOR (Two color full display)

Two colored lamp filters (silicone rubber bulb boots) are required for each unit. Use the color code described in this sequence: the first color code denotes the color to be used with the left lamp; the second color code denotes the color for the right lamp, as viewed from the panel front. These codes should be preceded by the code "J4". Example: J4 (RG) would produce a red and green indication in a full two-color display.

COLOR CODE			
(A)	AMBER	(R)	RED
*(B)	BLUE	*(W)	WHITE
*(G)	GREEN	*(Y)	YELLOW

*Not recommended for use with 115 VAC neon lamps.
*Light blue bulb is used for white illumination.

LENS FRAME

Select the lens most suited to your application and add the appropriate order code, N1 or N2, to the part number in the proper sequence. When ordering N2 lens for the Series 90K, omit the "G" lens type code and the "L" display screen code, since the N2 lens is available only in the G2 type lens. The standard color for the frame on the N1 lens is gray. Other frame colors such as black, red, white, etc., are available on special order. The standard color for the N2 lens is white, which is used with color filters. Other colors for the lens itself, for use without color filters, are available, such as red, yellow, green, etc. on special order. Also white and colored lenses with concave front surfaces are available on special order. Consult the factory for ordering information on special front lens colors and shapes.

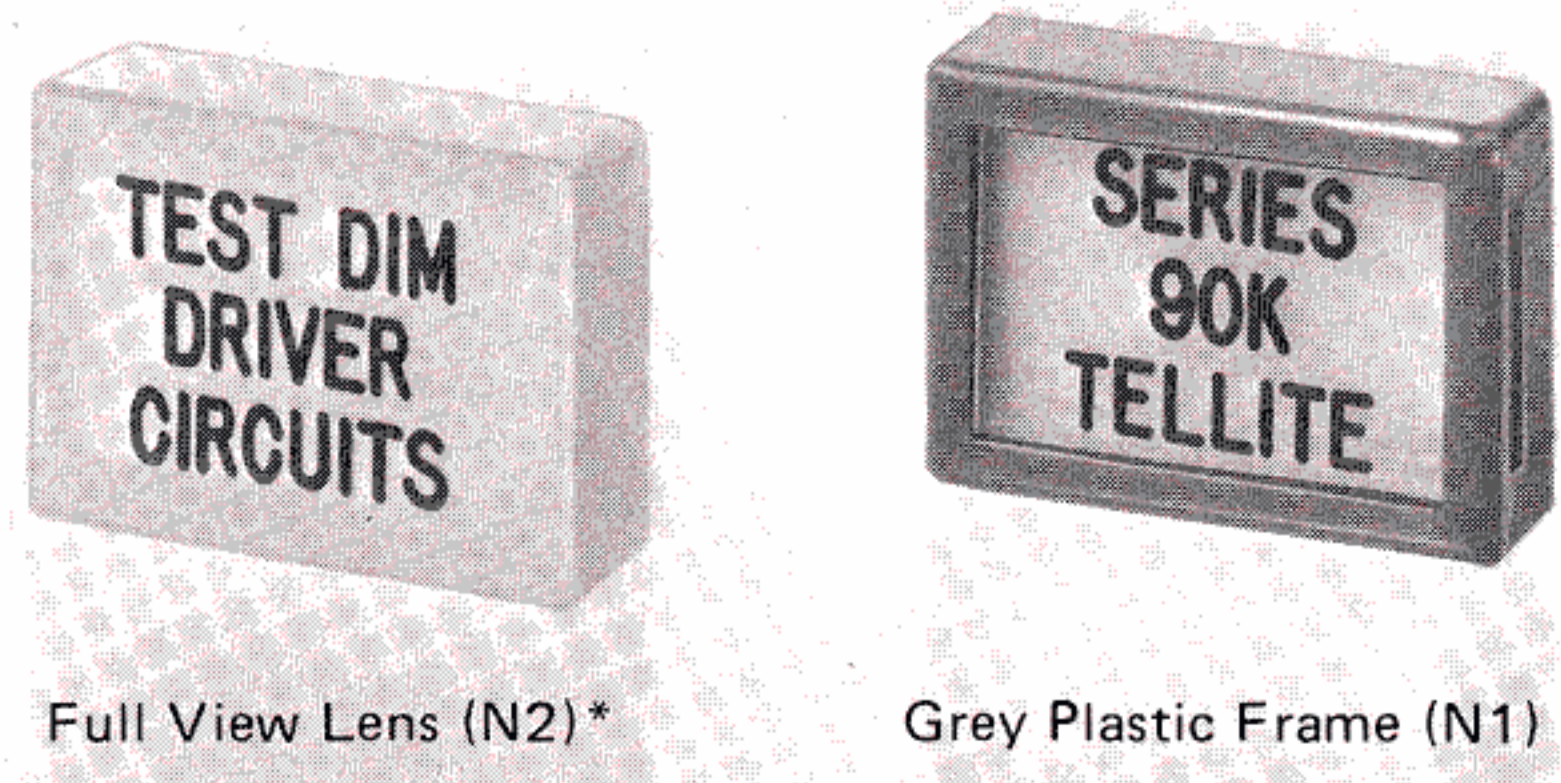

*Available in Lens Type 2 only (See page 5)

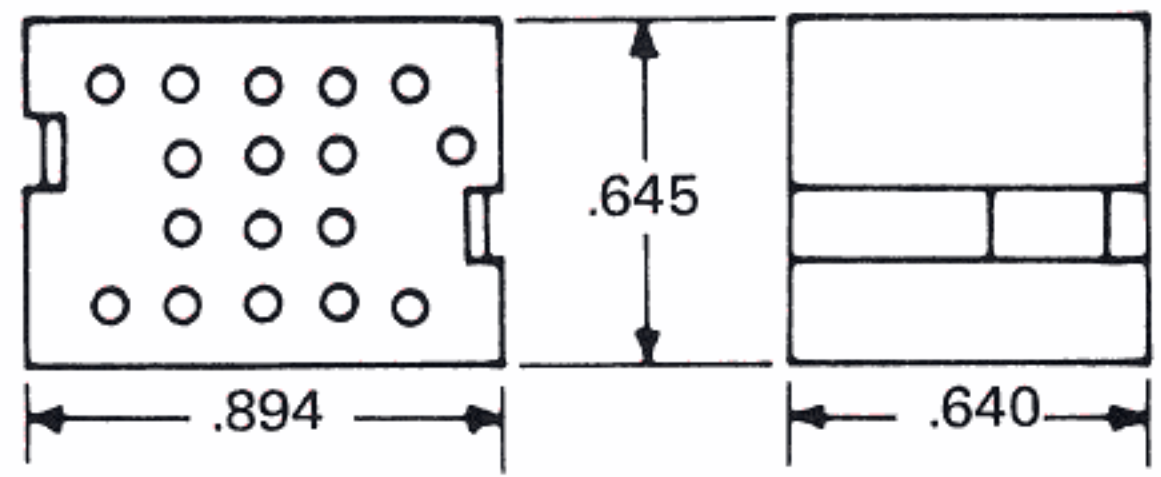
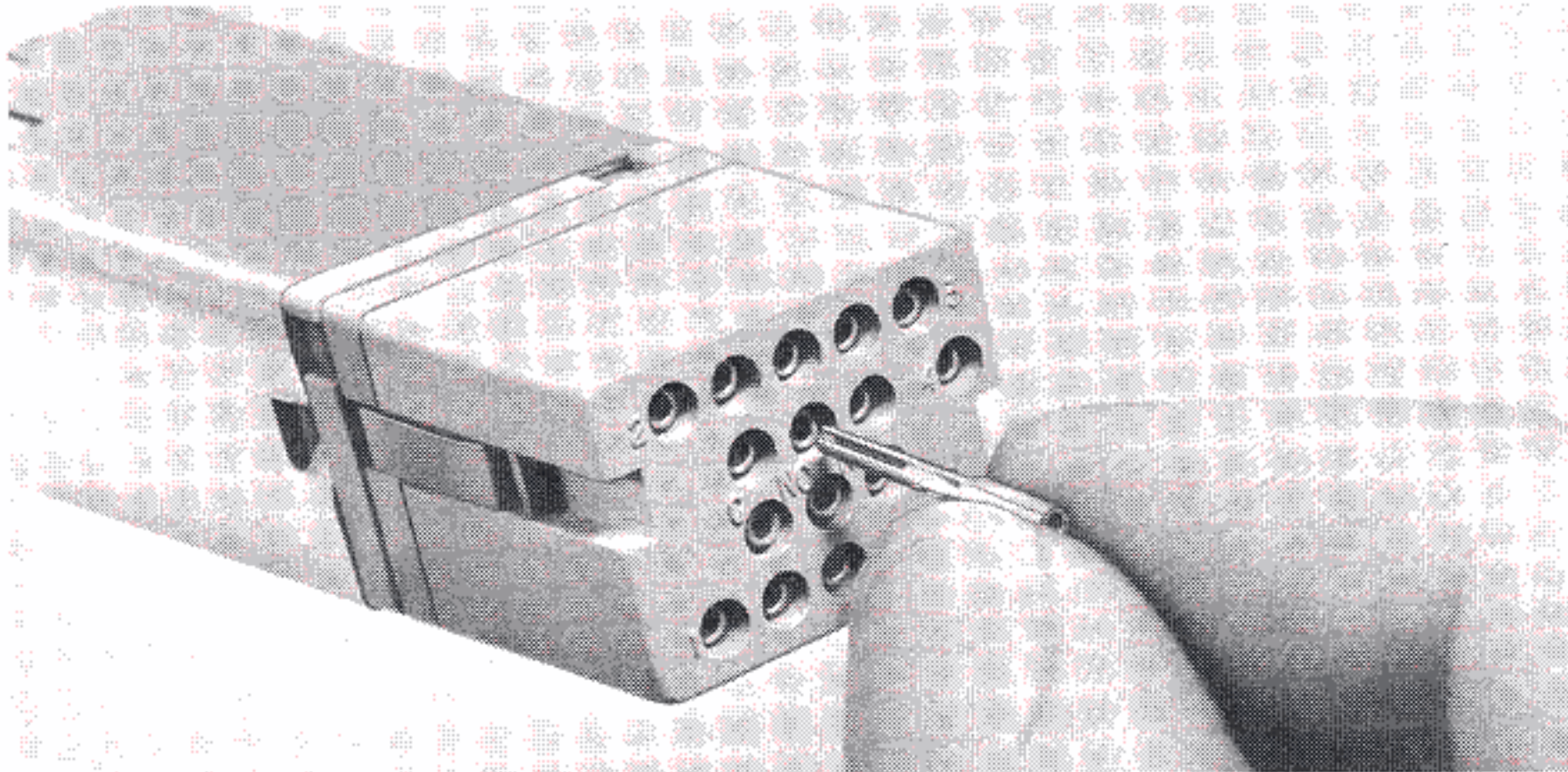
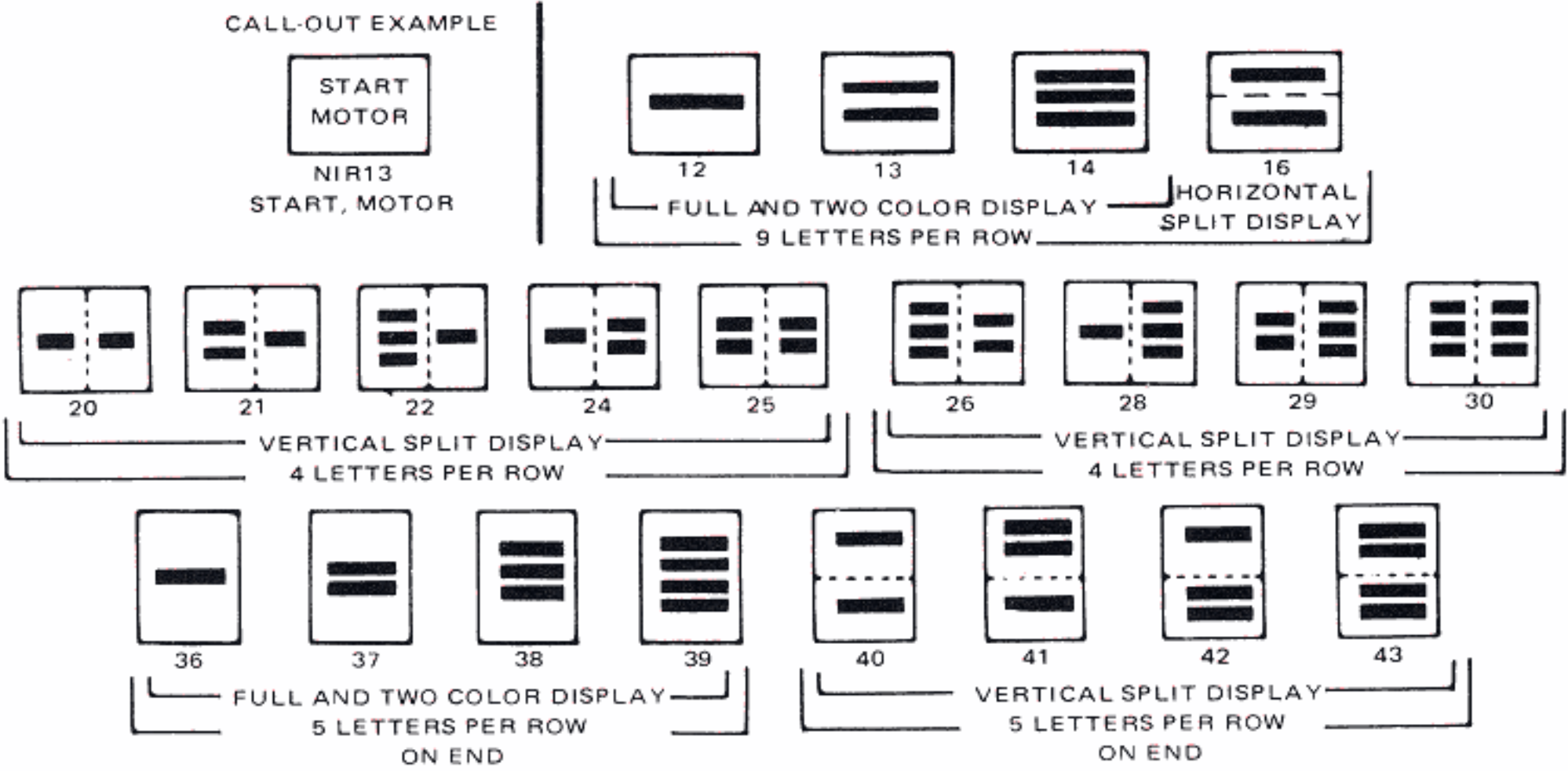

LEGEND CONFIGURATION

Engraving of the Series 90 unit lenses produces letters .110" ± .010 in height, with a .017 ± .005 stroke. Letters are filled with special black filler. To specify the engraving, add the letter "R" to the part number following the front lens code. The "R" code is then followed by the number or the engraving configuration desired, as shown in the illustration to the left. Use commas to separate rows of wording and a straight vertical line to separate splits.

CRIMP TYPE TERMINALS

A standard connector block which accepts crimp-type terminals is available for Series 90K units. This connector quickly snaps over the Series 90K connector pin terminals and offers the advantages of fast installation and replacement, as well as simplified wiring. To order the connector block, specify M S C part number 90K-600.

CRIMP TOOL AND LOCATOR

A standard MS3191 crimp tool and special M S C terminal locator that fits into the tool are used to attach each terminal to its wire. To order the crimp tool itself, designate with part number 800-22520/1-01 and turret head 800-22520/1-02. If you already have a MS3191 crimp tool, you will also need the special terminal locator. To order the applicable MSC terminal locator, use the following part number: 800-3191-L20 for terminals 800-CT20 or 800-CT20-3 and 800-3191-L20-2 for terminals 800-CT20-2.

CRIMP-TYPE TERMINALS

The crimp-type terminals used to wire the terminal blocks are also ordered as a separate item. These terminals are packaged in plastic bags, 25 terminals to the bag. Terminals may be ordered by using the part number 800-CT20. (Takes one #20, 22, or 24 gauge wire or two #24 gauge wires.) Part Number 800-CT20-2 takes one #26 or #28 gauge wire. 800-CT20-7 terminal for use with 90K-600 connectors provide standoff of .010" max. for block above P.C. board.

Terminals can be shipped from stock prior to shipment of the units. This permits advance attachment of the terminals to the wires and speeds installation when units arrive.

REMOVAL TOOL

Crimp terminals may be quickly removed from the connector block by using the M S C Removal Tool. To order, specify M S C part number 800-P7.



DRIP-PROOF SEAL

An easily installed, effective barrier that prohibits the entrance of liquids, or foreign matter through panel openings, without affecting visibility of legends or ease of switching. Assembly consists of a diaphragm which slips over the basic unit from the back, and a seal that fits over the front of the unit to provide an effective seal.

Order as part number 90K-502

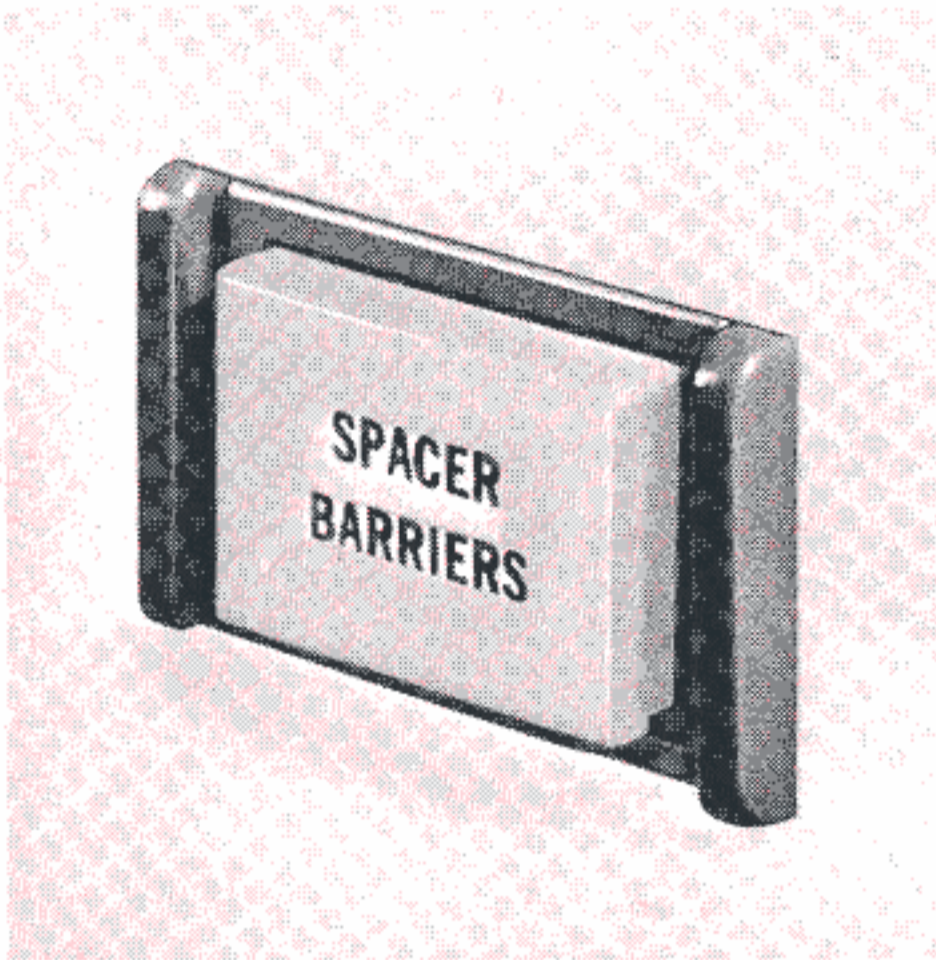

SPACER BARRIERS

Spacer Barriers are available for vertical or horizontal mounting with basic 90 units. As a safety precaution, the barriers preclude the possibility of inadvertently switching two adjacent units at the same time. For design purposes, barriers are available in a variety of colors as listed.

How to Order: Select vertical (short) or horizontal (long) barriers from the tables below, according to the desired colors. Two are required for one unit (and one each additional unit if rows are used).

Vertical Barriers for Horizontal Rows (Mount on Sides)		Horizontal Barriers for Vertical Rows (Mount on Top and Bottom)	
Part Number	Color	Part Number	Color
90K535(G)	Gray	90K536(G)	Gray
90K535(B)	Black	90K536(B)	Black
90K535(W)	White	90K536(W)	White
90K535(R)	Red	90K536(R)	Red

NOTE: Barriers are 0.125" thick. The added space required for barriers must be allowed for in the preparation of panel cutouts as detailed on Page 2. Allow 0.340 for the first unit and 0.125 for each additional unit in a matrix.

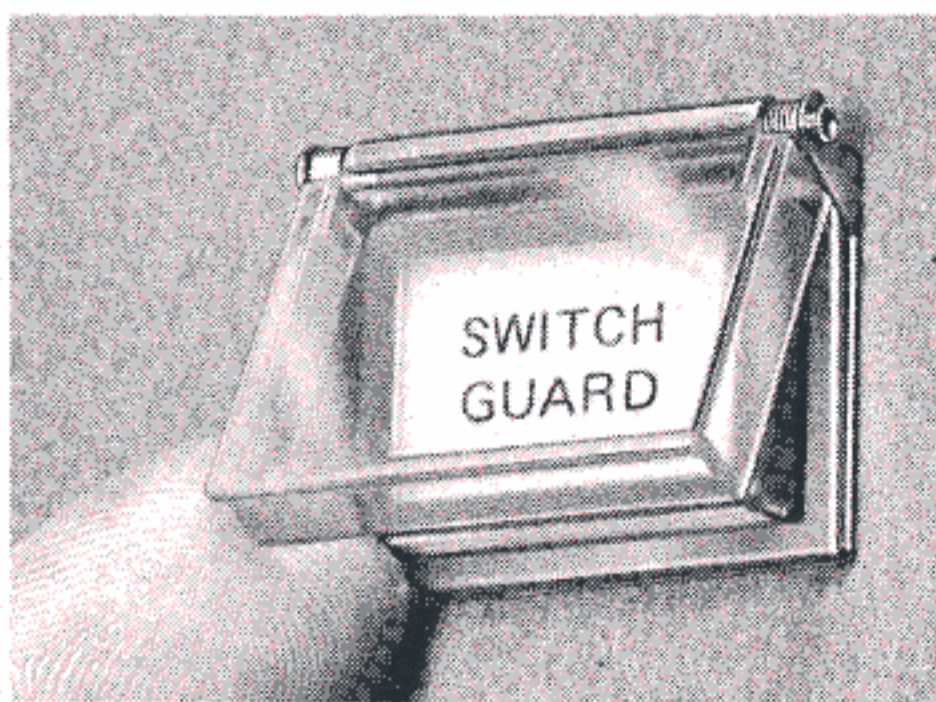

SWITCH GUARD

Positive protection against accidental switch actuation is provided by this spring-loaded, clear plastic cover. The spring holds the cover over the switch face at all times. To gain access to the switch face to actuate the switch, the cover must be raised by deliberate action.

How to Order: Switch Guards may be ordered separately by specifying Part Number 90K19.

How to Install: The installation of a Switch Guard can be quickly accomplished in the field. To install, remove the unit light capsule, loosen the mounting screws sufficiently to provide space between the frame of the switch unit and the panel front. Slip the Switch Guard onto the frame from the bottom of the frame. Tighten mounting screws securely and replace the light capsule.

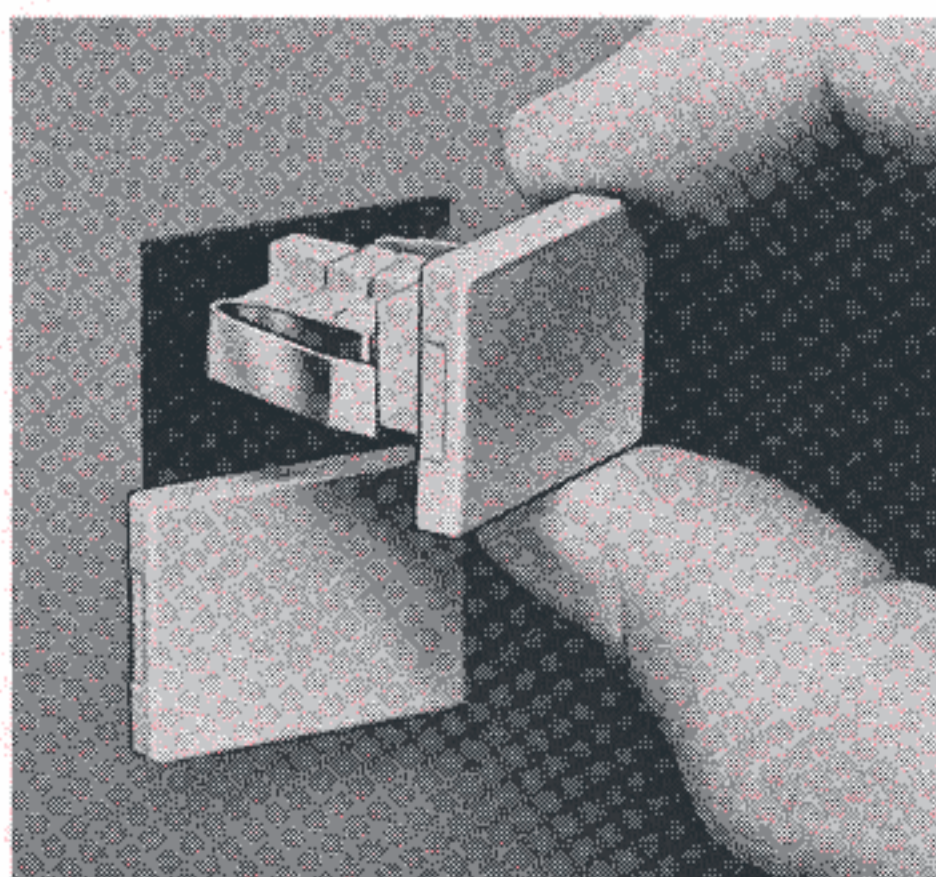

PANEL PLUGS

Panel plugs may be used to attractively cover cutouts which have been provided for future expansion, or which have been created by design changes. Each plug will fit any single cutout measuring 0.920" x 0.670". Plugs may also be inserted into vertical or horizontal rows of units to cover spaces allotted for one or several units. Dimensions of plug face are 3/4" x 1".

How to Order

Panel plugs may be ordered in various colors by using the part numbers shown below.

MSC Part Number	Color
90K542-1	Black
90K542-2	Red
90K542-3	Gray
90K542-4	White
90K542-5	Blue
90K542-6	Yellow
90K542-7	Green